

SIGN Series FLBS

Explosion Protected Warning & Alarm Devices



B Size

Zone 1,2,21,22



TECHNICAL DATA

TYPE	B Size
Marking to 94/9/EC	⊕ II 2 G D
Type of protection	Ex d IIB T6
Enclosure material	Copper free Aluminum
Transparent cover	Borosilicate Glass
Rated voltage	180~260 VAC or 12/24/48V AC/DC
Degree of protection acc to IEC 60529	IP 66
Permissible Ambient Temperature	-30°C to +55°C / -20°C to +40°C
Entries	Direct entry : 2 x 3/4" ISO 7/1 & 1x Ex d-blanking plug 3/4" Other thread forms available on request
Temperature class	T6
Size Code	B
Input Power	< 10 W
Viewing distance	Approx 25m
Color	(White-Green) or (White-Blue)

B Size

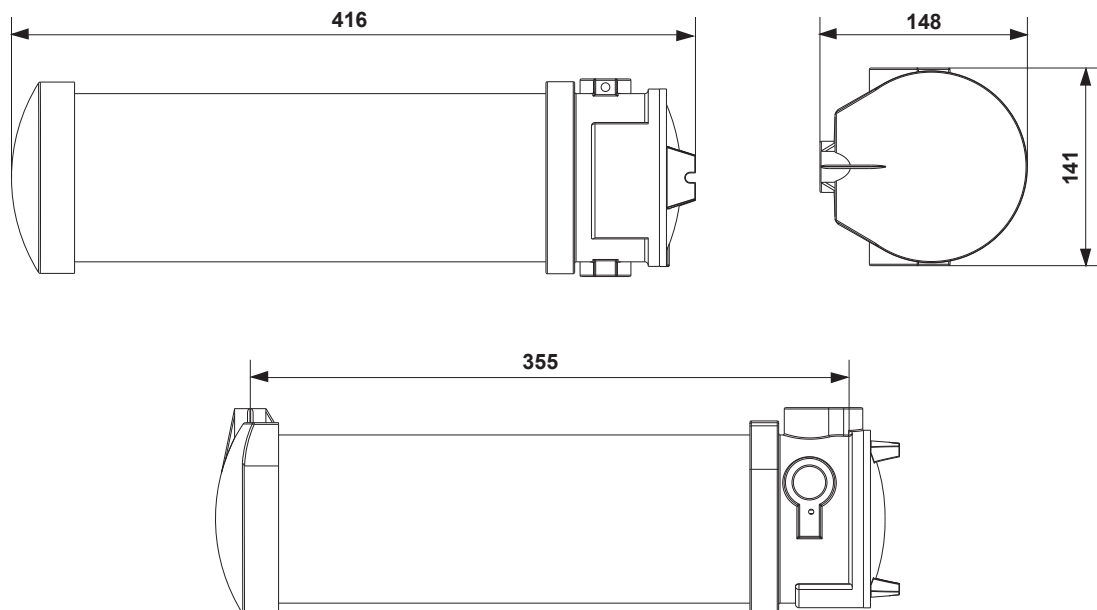

All information may be revised or changed by SHOMAL at anytime without prior notice or explanation.



SIGN Series FLBS

Explosion Protected Warning & Alarm Devices



Zone 1,2,21,22

B Size

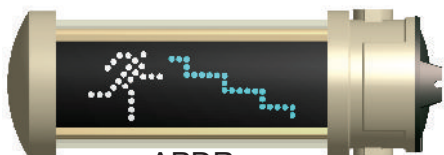

APDR



APDL



APUL

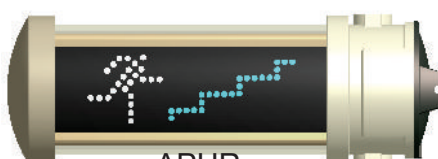

APUR

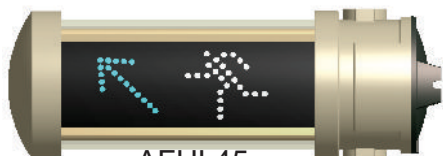

AFUL45

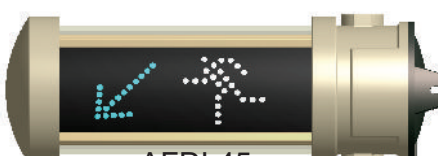

AFDL45



AFL

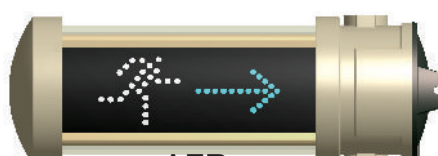

AFR



AFDR



AFDL



AFUR



AFUL



AFDR45

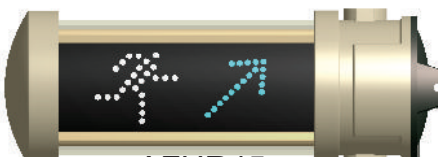

AFUR45

All information may be revised or changed by SHOMAL at anytime without prior notice or explanation.